



QTS
EXPERTS IN MESH

CORPORATE BROCHURE

MANUFACTURING WIRE MESH SOLUTIONS



STORAGE



SAFETY



SECURITY

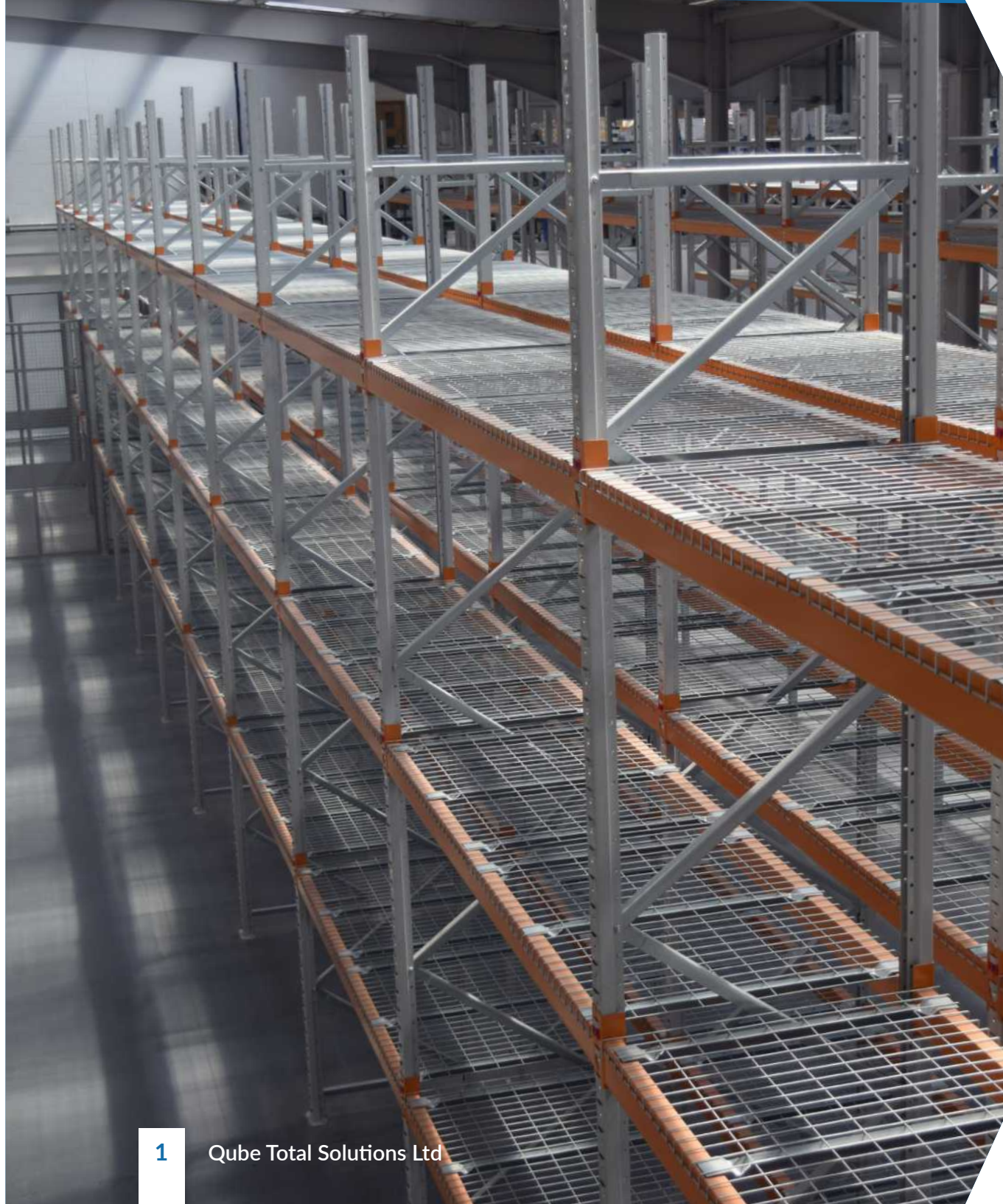

OUR COMPANY

Our vision is to be the leading UK manufacturer and the preferred, trusted partner of material handling solutions, supporting our clients on every scale, all around the world.

QTS are one of the few manufacturers of wire mesh products in the UK, which offers our customers an array of benefits. The biggest benefit is we can deliver a more hands-on approach at all stages of the process, maximising your satisfaction.

Since 2013, all QTS products have been designed and manufactured from our factory in Pinxton, using only tried and tested UK and EU steel producers. This ensures that our customers receive the best product possible. This is what makes us...

THE EXPERTS IN MESH.

EVERY MONTH, QTS PRODUCES:

40,000+
mesh decks

4,600+
kilometers of wire used

10,000m²+
of anti-collapse mesh

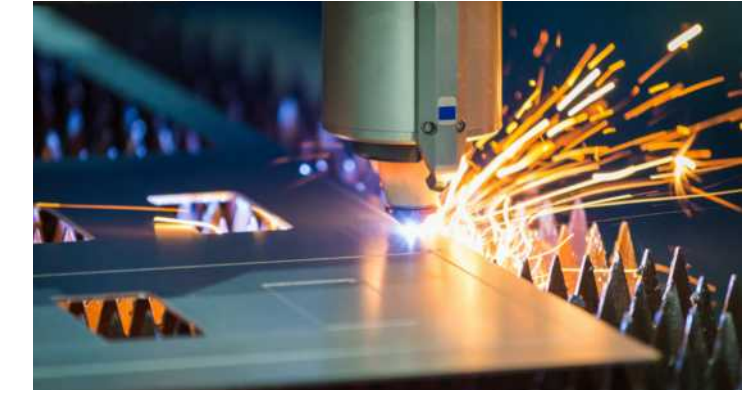

MAINTAINING BRITISH MANUFACTURING

QTS are proud members of Made in the Midlands, a branch of the Made in Group. The group was created to challenge the status quo about how people think about British industry and ensure the sector is connected and informed. As of today, the Made in Group is one of the fastest growing membership groups in the UK, with more than 500 members.

A PERSONAL SERVICE APPROACH...

At QTS, we pride ourselves on delivering our customers the best service possible.

We have been working hard to create an organisation that delivers the maximum value for our customers. Our customers are the reason that QTS is where it is today, so we will continue to develop our service skills and products to ensure we are the best we can be.



A TAILORED SOLUTION JUST FOR YOU...

No warehouse or manufacturing facility is the same, and here at QTS we understand that. We have a dedicated design and projects team who will guide you through the process of designing a totally bespoke solution for your space.



1-2-1 ACCOUNT MANAGEMENT

As part of our commitment to customer satisfaction, each customer is allocated a dedicated account manager. This means that you will always be dealing with the same member of our team. This will allow you to develop a relationship with your account manager which will allow you to work in the way that you prefer. We love to develop the relationship between ourselves and our customers, so our sales team are always available to come out and visit you or your site.

- ✓ Standard quotes returned the same day
- ✓ 12 month product warranty
- ✓ Credit accounts available
- ✓ Competitive credit terms

DEDICATED PROJECTS TEAM

QTS prides itself on being the leading UK mesh manufacturer for bespoke projects. We have an in-house team of experts who are always on hand to provide project by project assistance, from the initial design phase, all the way through to overseeing phased deliveries.

We know that with large projects there can be a lot of spinning plates, so our dedicated projects team can offer that hands-on approach to project management, that most of our competitors do not offer.

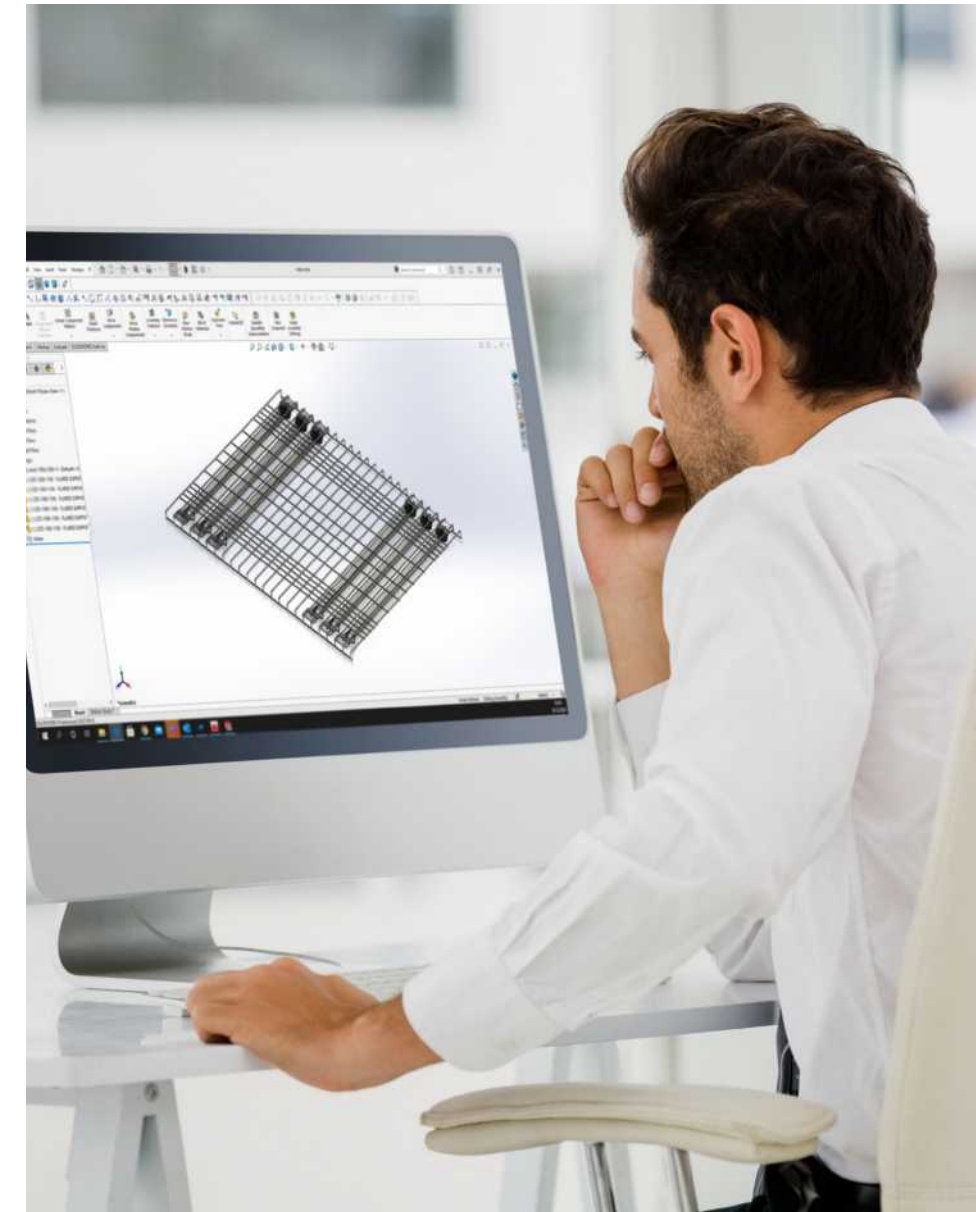
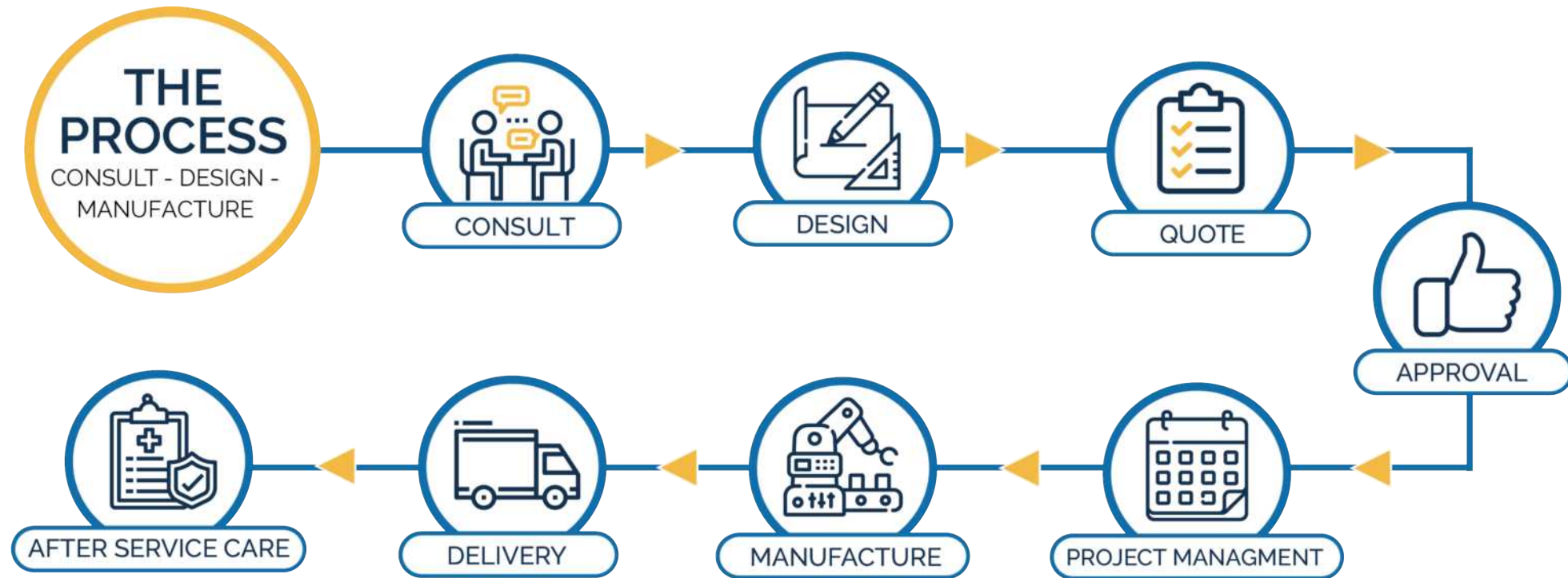

A QUALITY PRODUCT STARTS WITH A QUALITY DESIGN...

Design is imperative to the manufacturing of any product, which is why we have a team of in-house designers to make sure our products are the quality that our customers deserve.

Being the leading UK manufacturer of wire mesh products, it is important to us that we provide our customers with the best and most suitably designed products possible.

Our team of designers work on everything from our stock items through to completely bespoke solutions. If you have an idea or a problem that needs solving, then our design team will work with you to produce a cost-effective and fit for purpose solution.



easySHELF™ WIRE MESH DECKS

STORAGE MADE EASY...

easySHELF™ wire mesh decks are a low weight, high strength, wire mesh decking system that is suitable for storing palletised goods or single units in a secure and simple way.

easySHELF™ mesh decking provides an unmatched combination of innovative design, performance, and value for money.

Manufactured using high quality, approved, UK and EU sourced materials to the highest standards at our production facilities in the UK.

- ✔ An average of 70% permeable surface, making it favourable amongst insurers.
- Compliant with sprinkler systems
- ✔ Rapid installation as a result of the waterfall design; no fixing required.
- ✔ Customisable support bars to suit food, science, and medical environments.
- ✔ Variety of depths, widths and weight loading available.
- ✔ Competitive lead times on stock products

STANDARD STOCK DECK RANGE...

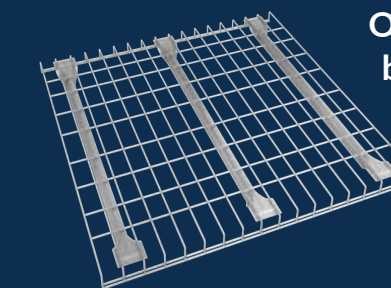

Our range of standard stock decks have been created to suit the most common sizes of racking available. These are available on shorter lead times than bespoke options and are more cost-effective.

STOCKED SIZES:

To suit 900mm deep bay:

» 906mmx1324mm

To Suit 1100mm deep bay:

» 1106mmx884mm

» 1106mmx1080mm

» 1106mmx1104mm

» 1106mmx1190mm

» 1106mmx1324mm

SPECIFICATION:

- » 4mm wire diameter
- » 55x100mm mesh aperture
- » Waterfall design
- » 3 inverted flared support bars
- » 1.5mm support bar material
- » 1,000kg weight-loading UDL spanning the beams

BESPOKE SIZES AVAILABLE ON REQUEST.

CREATE A COMPLETELY BESPOKE SOLUTION BY CUSTOMISING PARTS OF YOUR MESH DECK...

No warehouse or manufacturing facility is the same. So why would a standard deck be up for the job?

At QTS, we have a flexible system that allows customers to tailor their decking solution, so they have the most suitable deck for its application.

MESH APERTURES:

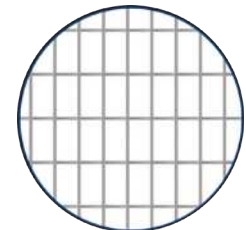

55mm X 100mm

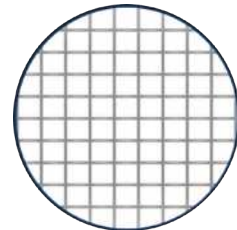

55mm X 50mm

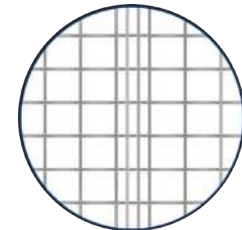

CUSTOM APERTURES

COATINGS:



PRE-GALVANISED



HOT-DIPPED

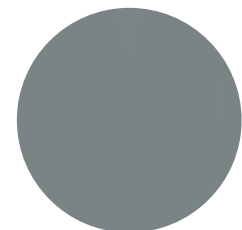

POWDER COATED

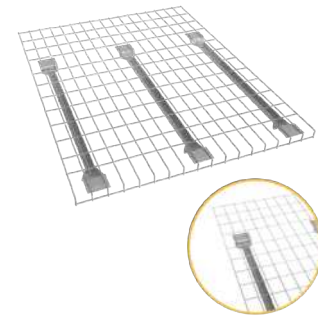

OVERHANG:

Overhang decks are a variation of the waterfall design with an extended mesh extension for loads larger than the beam depths. (Note, this is only designed to support a slight overhang of the pallet, it is not to be used as extra load space)

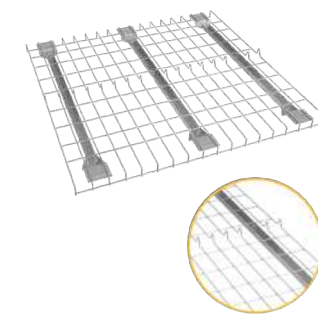

CENTRAL RIDGE:

A simple but effective central ridge to create a guide for tote box storage. This is a handy feature to add if you want to be able to load a bay from either side without having to worry about how far on you push the items.

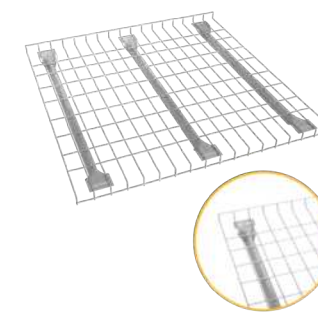

UPSTAND:

Create an integral barrier to assist with correct pallet position and help keep flue spaces free. It is also an effective way to store multiple items a few rows deep, without having to worry about them falling off the back of the racking.

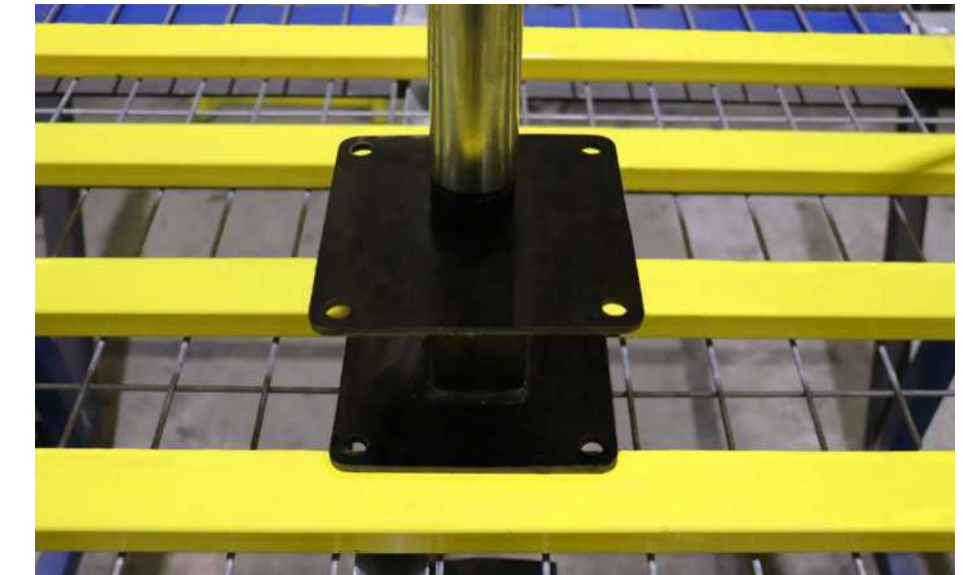

DON'T RISK AN ACCIDENT; MAKE SURE YOUR DECKS ARE TESTED...

In addition to using strong UK and EU sourced materials, our easySHELF™ wire mesh decks are tested in accordance with the ANSI standards. Our testing equipment is designed to replicate the loading conditions, applying a force onto the deck much like a uniformly distributed load would. This means you will be able to supply your customers with evidence that the product is fit for purpose. Even if you require a particularly bespoke solution, we can arrange for a test deck to be manufactured and then tested before you confirm the order; another bonus of using a UK manufacturer.



easyDIVIDER™ WIRE MESH DIVIDER

AN ORGANISED WAREHOUSE IS AN EFFICIENT WAREHOUSE

The easyDIVIDER™ system is used to separate your stored items and to be able to create smaller shelf locations by compartmentalizing the storage level. The easyDIVIDER™ is a unique and adjustable system that has been designed to fit any standard pallet racking or long-span shelving.

The dividers are clipped on to of the deck, enabling the individual divider to be positioned according to the customer's specific needs. They are available in a range of styles, finishes, and colours using only the highest quality steel.

CHOOSE FROM...

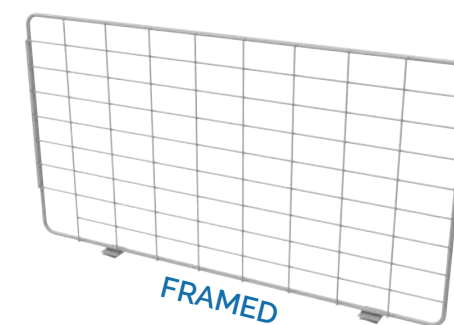

CREATE THE PERFECT PICKING BAY USING THE Z-DIVIDER...

The z-divider has been designed to be fixed at the back of the bay. This then acts as a backstop for smaller or boxed items that prevent them from falling off the back of the bay. When combined with the standard or framed easyDIVIDER™, the z-divider creates the perfect picking bay for a high-speed logistic operation.

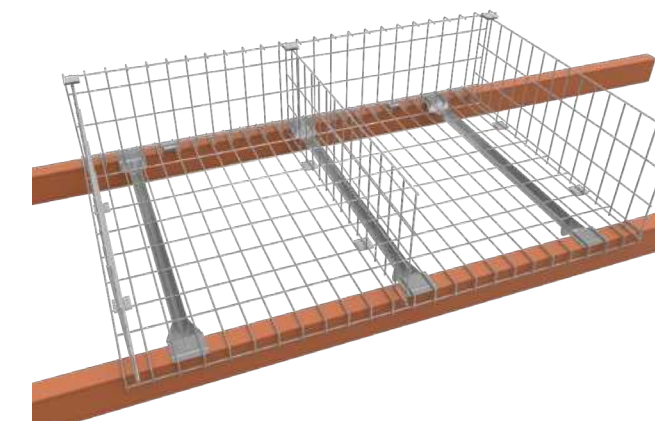



easyBAR™ PALLET SUPPORT BARS

PROVIDING YOU WITH THE SUPPORT YOU NEED...



STANDARD PALLET SUPPORT BARS

The QTS easyBAR™ pallet racking support bar can be fixed between the beams within pallet racking systems, providing additional support to heavy palletised loads or potentially damaged pallets.

The easyBAR™ comes in many different designs to suit varying needs. The most popular options are the standard pallet support bar that lays flat to the beams and the raised support bars that allow for easy forklift entry.



RAISED PALLET SUPPORT BARS

✓ Made from high quality, heavy-duty steel for additional strength

✓ Cost-effective solution to help protect against improper loading or broken pallets

✓ Simple and fast to install therefore reducing installation cost



GARMENT PALLET SUPPORT BARS



rackGUARDIAN™ ANTI-COLLAPSE MESH

SUPERIOR SAFETY SOLUTION...

The rackGUARDIAN™ anti-collapse mesh system is designed to secure onto the back of pallet racking systems or in the flue space between two runs of racking.

Constructed from framed mesh panels and attached via secure brackets, the anti-collapse system will provide a physical barrier at the rear of the racking system, preventing items from falling and protecting pedestrianised areas below.

This simple yet innovative solution has a modular design and can therefore be adapted to suit any racking types and sizes, withstanding up to 2,500 joules of pressure.

Additionally, the simplistic design is easy and fast to install, which will reduce installation costs making the rackGUARDIAN™ an even more cost-effective solution.

- ✓ Modular design
- ✓ Improved warehouse safety
- ✓ Easy to install
- ✓ Industry standard sizes
- ✓ Available in 7 days

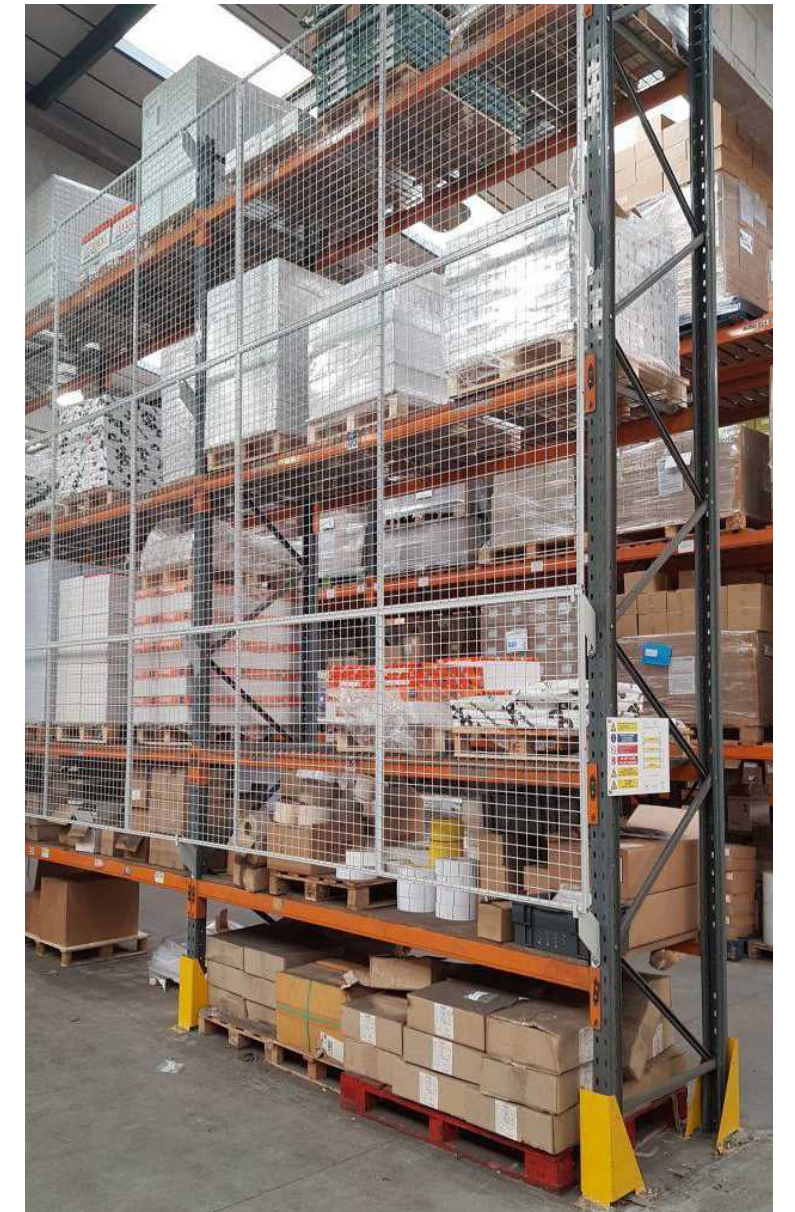

CONFIGURING YOUR PANELS...

The anti-collapse panels are designed to be installed in a brickwork pattern for increased stability. In addition, panels are installed with the largest panels at the bottom of the screen, leading up to the smallest panels at the top for ease of installation, as the diagram illustrates.

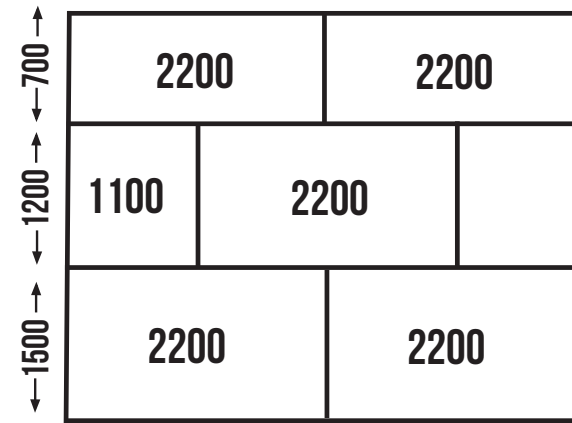

2 TYPES OF BRACKET FOR ALL TYPES OF RACKING...

Designed to eliminate the need to tek screw anti-collapse panels onto the back of racking systems, our stand-off brackets provide the perfect solution, as it does not compromise the structural integrity of the racking system.

Constructed from 3mm thick steel, the stand-off brackets are super strong; this is because QTS only use reputable UK/ EU steel manufactures. The brackets are all finished in RAL7042 (traffic grey) however, If you would like a bespoke colour, please contact our sales team.

SPECIFICATION:

- » 20x20mm framed box section
- » 50x50mm standard mesh aperture
 - 25x25mm available on request
- » 3mm wire gauge
- » Powder coated finish (RAL 7042)
 - Other colours available on request

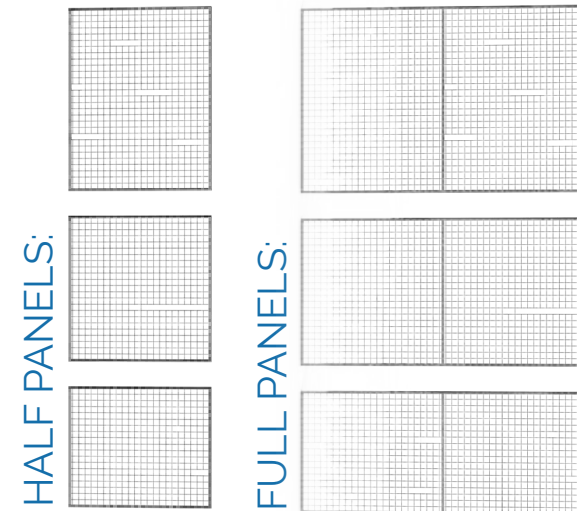

STOCK SIZES:

Bespoke sizes available on request.

Panels: (height x width)	Brackets:	
	Standard:	Flat:
1100mmx700mm	100mm	100mm
1100mmx1200mm	150mm	150mm
1100mmx1500mm	200mm	200mm
2200mmx700mm	250mm	250mm
2200mmx1200mm	300mm	300mm
2200mmx1500mm		



STANDARD BRACKET:

The standard bracket is the most commonly used in the industry. This is attached to the rear of the racking with a 90° bend that creates the standoff between the upright and the panels.

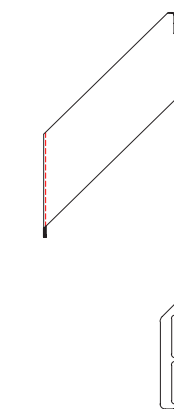

FLAT BRACKET:

The flat brackets are side mounted opposed to being attached on the rear to suit side nodule uprights.

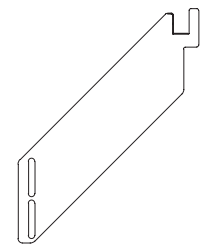



storGUARD™

MESH PARTITIONS & CAGES

KEEPING YOUR GOODS SAFE...

storGUARD™ is a modular industrial mesh partitioning and cage system for warehouse and factory facilities. The system is made up of welded mesh panels, doors, and posts to make up a secure structure that can keep products and machinery out of reach of unauthorised personnel. Steel partitioning is a great way to create restricted access areas for quarantine goods, hazardous substances, or high-value items.

Our storGUARD™ partitions are created with framed panels which provides strength and rigidity for long-lasting warehouse security. Made from welded wire mesh, each panel is supported by sturdy steel posts which bolt directly to the floor. Our doors come with a variety of locking options, but our standard staple and hasp lock will provide all the security you will need.

- ✓ The modular design allows you to easily customise the system to your required specifications.
- ✓ Easy to install reducing labour costs
- ✓ Designed for high security
- ✓ Available heights of 2200mm, 3300mm & 4400mm (bespoke sizes available on request)
- ✓ Available on short lead times

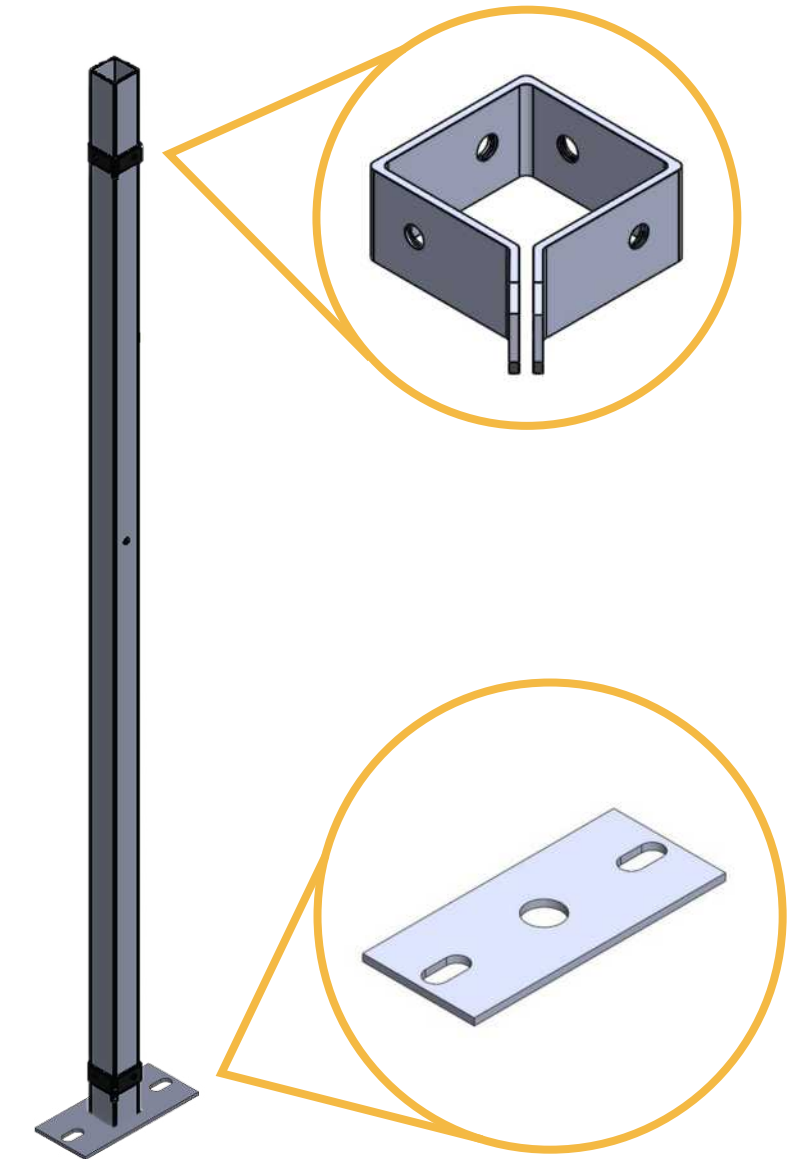



A COMPLETELY MODULAR DESIGN ALLOWING FOR CUSTOMISATION...

The storGUARD™ system is completely modular in design meaning it is easy to create any cage shape or free-standing partition that you require. A variety of door options available that can replace the panels to create an opening for operatives to gain access.

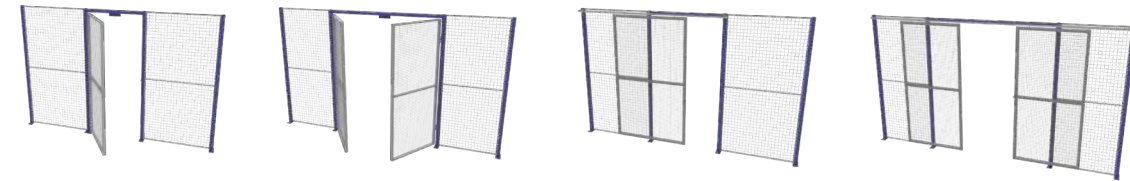

STOCK PANEL SIZES:

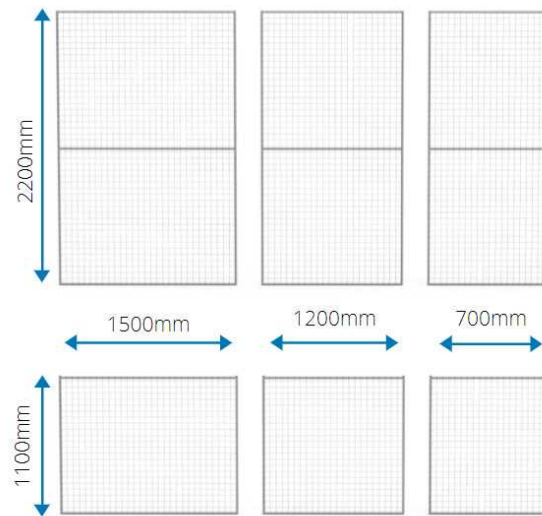

DIGI LOCK:



LATCH DEADLOCK:



QUICK EXIT ADDITION:



AVAILABLE WITH A VARIETY OF LOCKING OPTIONS...

Our lock partners, Gatemaster, provide an internationally renowned range of easy to fit locking systems that will suit any situation. As a result of the design of our storGUARD™ doors, you can easily change out the locking system to re-purpose our door systems without having to replace the entire door unit.



- ✓ Easy to fit - Slim 70mm wide stainless steel lock case along with adjustable and removable deadbolt ensure easy fitting to gates
- ✓ Simple deadlock action, gate remains open until key is turned
- ✓ Deadbolt is adjustable in length for precise fitting on site. Suitable for left and right handed gates
- ✓ Supplied with bolt support plate.



QTS
EXPERTS IN MESH

Enterprise House, Brookhill Road,
Pinxton, Nottingham, NG16 6NS

enquiries@qts-ltd.co.uk

www.qts-ltd.com

01455 633567